

Ecoflam

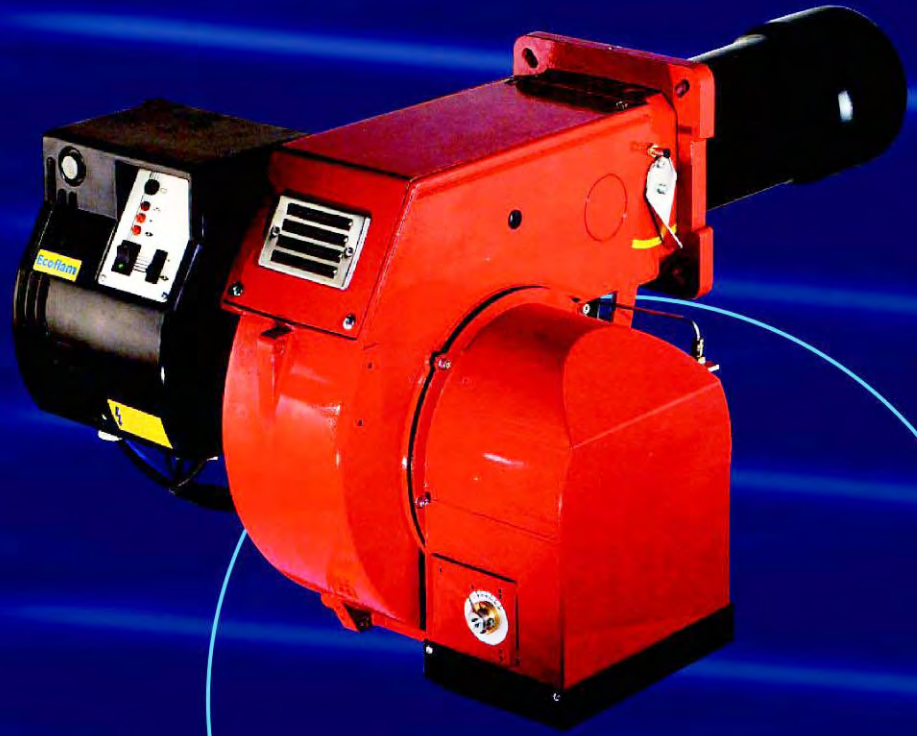

**MAIOR**



**Ecoflam**



# Ecoflam

## LIGHT OIL BURNERS

### 轻油燃烧器



Ecoflam was founded in 1973 in Castelfranco Veneto, near Venice in the North East of Italy. For more than thirty years Ecoflam has continued to develop all its products with constant dedication and determination addressing Technological Research, Ecology, Energy Saving, and Safety.

Ecoflam today offers a full range of blown air pressure jet burners designed and tested in our "GREEN" modern laboratories. All products conform to CE standards and are manufactured in accordance with ISO 9001 and VISION 2000 certification.

Ecoflam burners guarantee high efficiency and reliable operation with significant energy savings. All models feature extreme ease of installation maintenance and flexible boiler - burner matching.



MAIOR P 600.1 PR



意高（意大利）燃烧设备有限公司在1973年位于意大利北部近威尼斯的Castelfranco Veneto成立。拥有超过30年经验的意高公司，仍不断致力发展各类的产品，并且决心专注技术研究、生态保护、节约能源及安全性等。

意高公司今天能提供各类型的压力吹风式燃烧器。所有燃烧器都在“GREEN”绿色环保实验中心设计及测试，产品全通过CE标准及按照ISO9001及VISION 2000证书标准生产。

意高公司燃烧器保证有高效能，可靠的操作性及高节能特性。所有型号均带有容易安装维修及灵活与锅炉配套使用的特性。

## OPERATION / 操作模式

<b>P...</b>	On-Off
<b>P...AB</b>	HI-LOW with servomotor
<b>P...AB HS</b>	HI-LOW with hydraulic system
<b>P...PR</b>	Progressive
<b>P...MD</b>	Modulating

单段火  
 伺服马达控制-两段火  
 液压式控制-两段火  
 渐进式  
 比例调节式

## MAIN FEATURES / 主要特点

- Aluminium casing up to Maior P 400.1 and steel casing from P 500.1 with electrical panel integrated on the burner.
- New high efficiency fan ventilator designed to give flame stability and ease of matching.
- Adjustable combustion head .
- Hi - Low version available with hydraulic system or electric servomotor with two nozzle from Maior P 35 to Maior 300.1 and with 3 nozzles available up to Maior 600.1.
- New designed proportional pressure ratio system for the progressive PR and modulating version MD.
- Modulating version with PID system controller with digital set point display and real time value.
- Progressive or modulating nozzle with flow return. Shut down flow system on the nozzle managed by coil from Maior P 700.1.
- Firing head with automatic adjustable system for primary air that changes according to output required from Maior P 700.1.
- Easy maintenance with sliding bars system. On request from Maior P 300.1 and standard from Maior P 700.1.
- On request tailored solutions of flame shape.
- All burners feature high versatility on different types of domestic, commercial and industrial application.



MAIOR P 300.1 P AB



MAIOR P 150.1 P AB

- Maior P 400.1型号以下采用铝质外壳  
Maior P 500.1型号或以上则采用钢质外壳并装配控制箱在燃烧器上。
- 采用特别设计的高效率风机能提供高稳定性火焰及易于配套设备。
- 可调节燃烧头。
- 两段火型号配备液压系统或伺服马达。  
由 Maior P 35 至 Maior P 300.1:采用双油咀  
由 Maior P 400 至 Maior P 600.1:采用三油咀
- 渐进式PR及比例调节式MD型号均采用全新设计压力比例调节系统。
- 比例调节型号配备数字设定点和实时数值显示的PID系统控制器。
- 渐进式或比例调节油咀都有回油路。由Maior P 700.1以上型号，油咀在供油路的关闭则由电磁线圈所控制。
- 由 Maior P 700.1 以上型号，自动调节燃烧头可按输出功率要求而改变一次风量。
- 滑动式推杆设计易于维修。  
由 Maior P 300.1起，可按要求安装。  
由 Maior P 700.1起，定为标准配置。
- 火焰形状可按要求更改。
- 所有燃烧器具有多用途特性在住宅、商业及工业应用方面。

## WORKING FIELDS / 工作范围

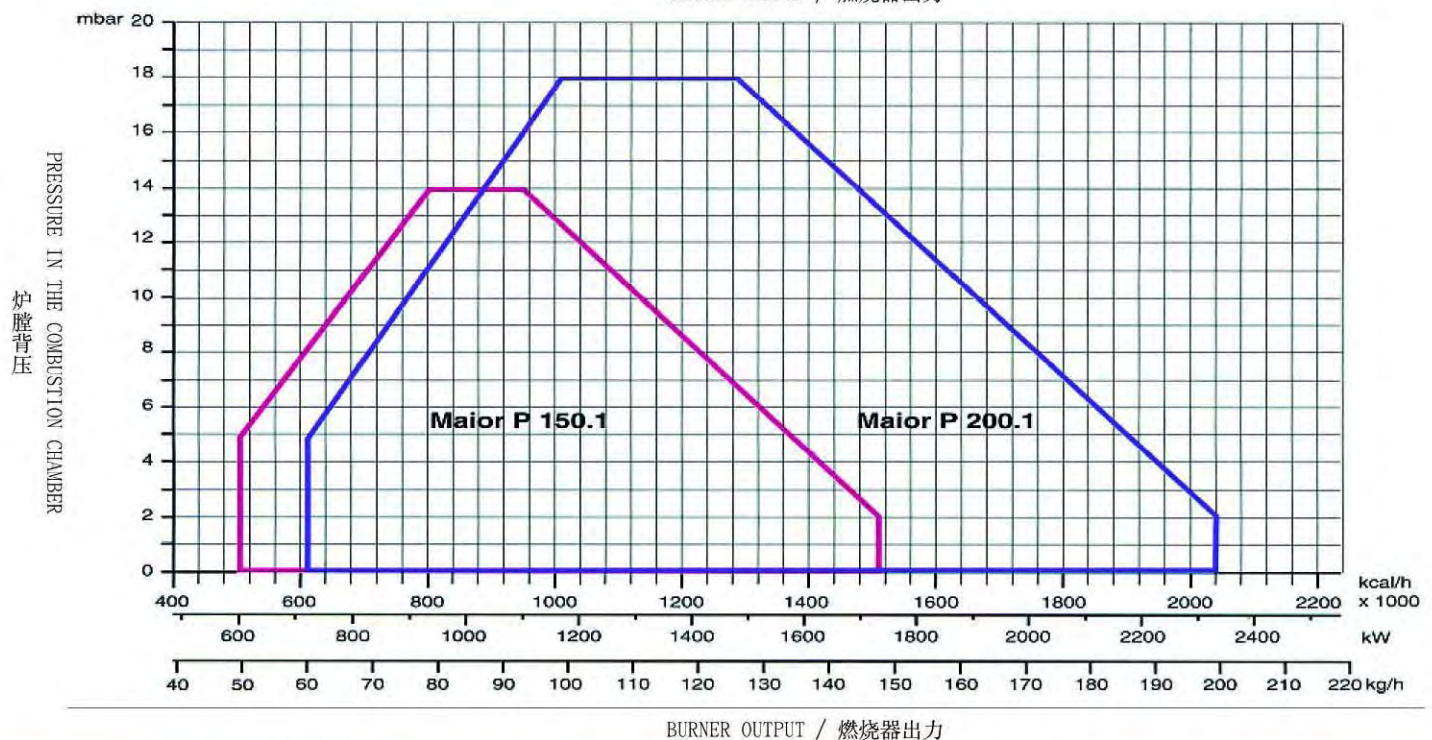
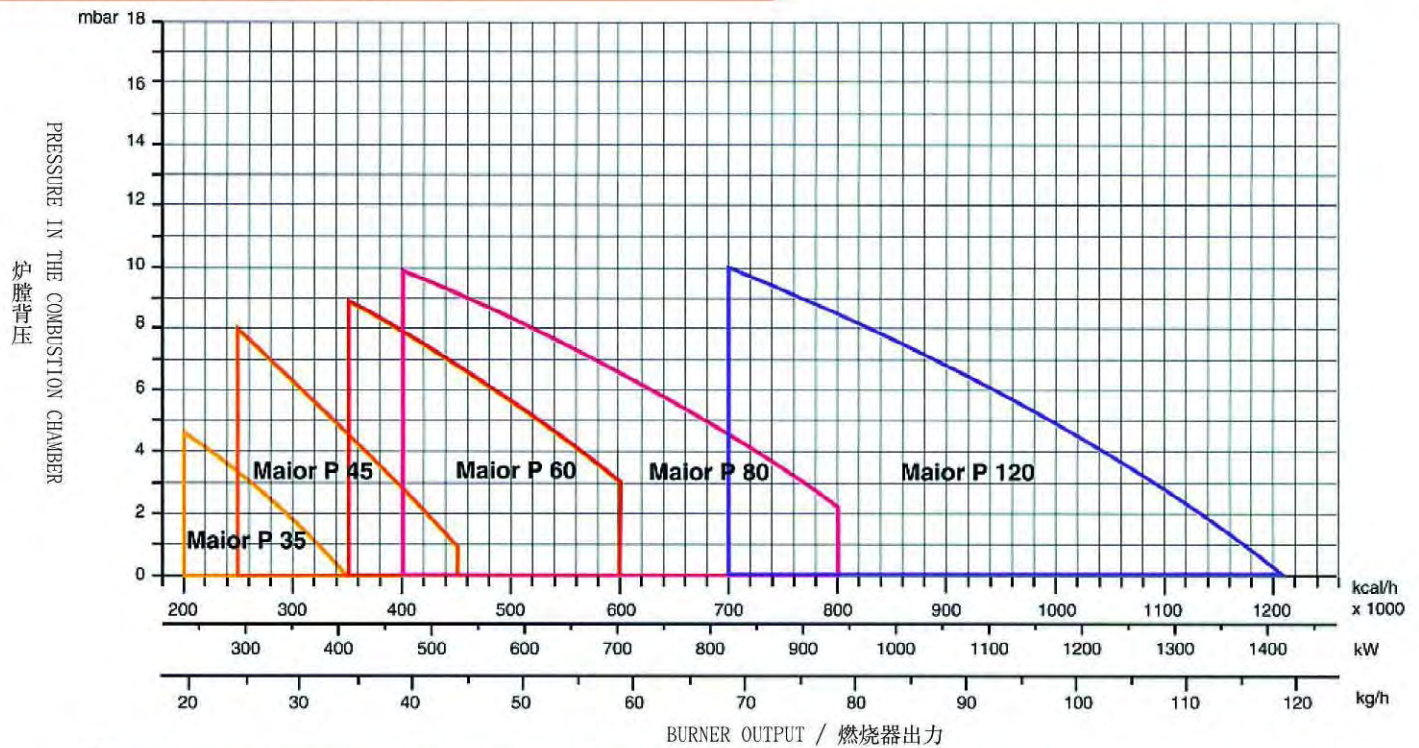

## TECHNICAL DATA / 技术数据

MODELS 型号	Output 最大输出 max.		Output 最小输出 min.		Flow rate 最大流量 max.	Flow rate 最小流量 min.	Power supply 电源	Motor 马达	Operation 操作
	kW	kcal/hx1000	kW	kcal/hx1000	kg/h	kg/h	V	kW	
MAIOR P 35	415	350	237	200	35	20	230/400	0.370	P-AB
MAIOR P 45	532	459	296	255	45	25	230/400	0.550	AB-PR-MD
MAIOR P 60	710	600	415	350	60	35	230/400	0.740	AB-PR-MD
MAIOR P 80	949	800	474	400	80	40	230/400	1.1	AB-PR-MD
MAIOR P 120	1,423	1,200	830	700	120	70	230/400	2.2	AB-PR-MD
MAIOR P 150.1	1,780	1,530	592	510	150	50	230/400	3	AB-PR-MD
MAIOR P 200.1	2,372	2,040	710	612	200	60	230/400	4	AB-PR-MD
MAIOR P 300.1	3,000	2,586	1,000	867.3	250	85	230/400	7.5	AB-PR-MD

Fuel: Light oil (L.C.V. 10,200 kcal/kg max. visc 1.5°E at 20°C)

燃料: 轻油 (热值 10,200 kcal/kg 最大黏度 1.5°E at 20°C)

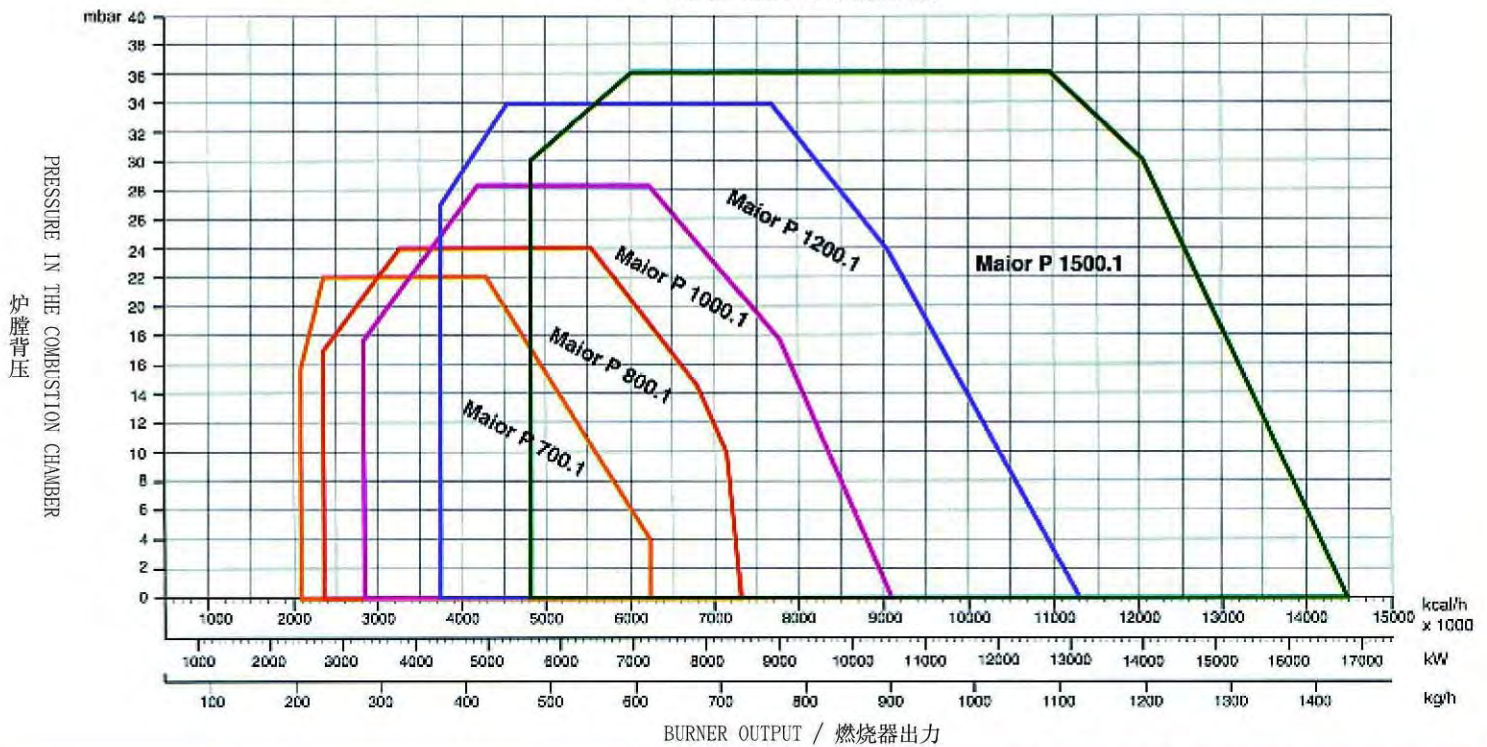
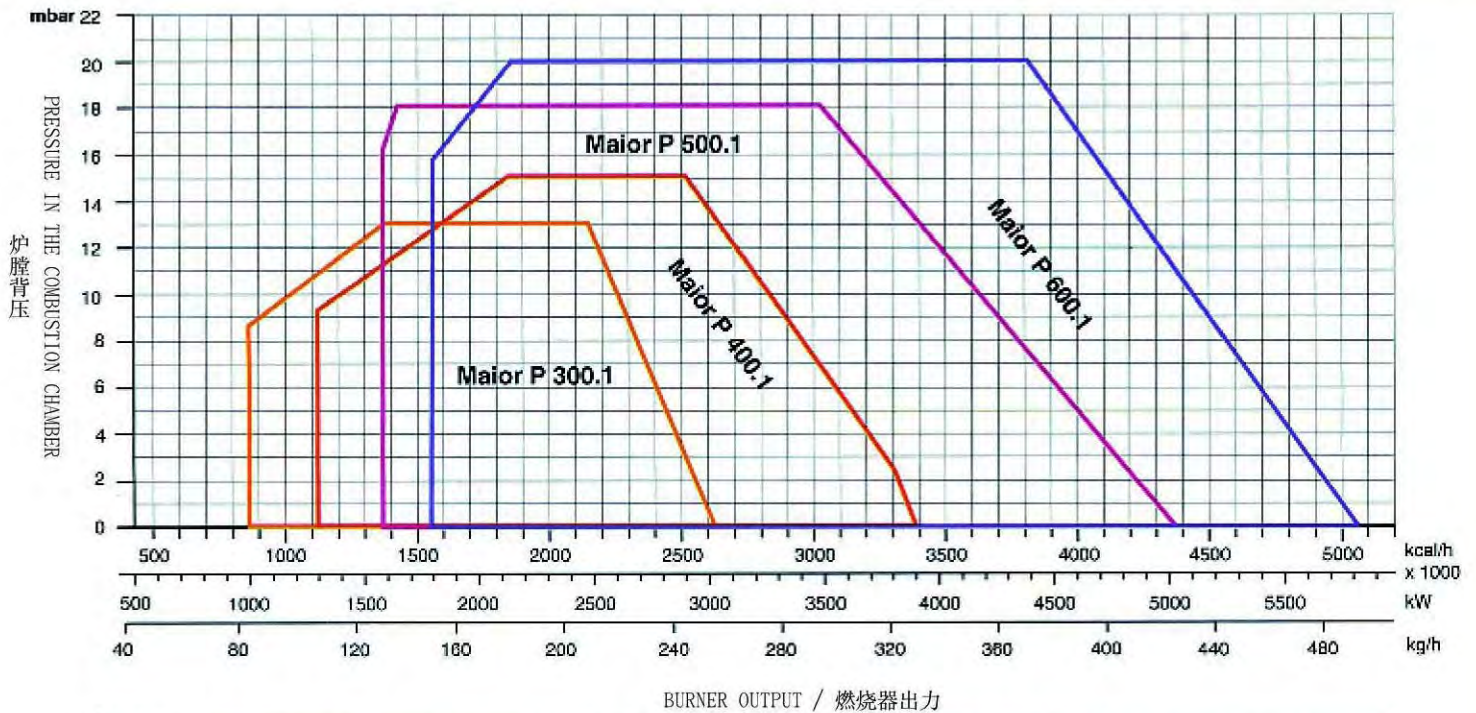

TECHNICAL DATA / 技术数据

MODELS 型号	Output 最大输出 max.		Output 最小输出 min.		Flow rate 最大流量 max.		Flow rate 最小流量 min.		Power supply 电源 V	Motor 马达 kW	Operation 操作 AB-PR-MD
	kW	kcal/hx1000	kW	kcal/hx1000	kg/h	kg/h	kg/h	kg/h			
MAIOR P 400.1	3,900	3,362	1,300	1,127.5	350	110	230/400	9	AB-PR-MD		
MAIOR P 500.1	5,000	4,310	1,578	1,368.6	422	134	230/400	11	AB-PR-MD		
MAIOR P 600.1	5,800	5,000	1,795	1,556.8	490	153	230/400	15	PR-MD		
MAIOR P 700.1	7,250	6,250	2,417	2,096.27	613	205	230/400	15	PR-MD		
MAIOR P 800.1	8,500	7,327.5	2,750	2,385.1	718	234	230/400	18.5	PR-MD		
MAIOR P 1000.1	10,500	9,052	3,300	2,862.1	887	281	230/400	22	PR-MD		
MAIOR P 1200.1	13,100	11,293.1	4,367	3,787.5	1,107	371	230/400	37	PR-MD		
MAIOR P 1500.1	16,800	14,448	5,600	4,818	1,416	472	230/400	45	PR-MD		

Fuel: Light oil (L.C.V. 10,200 kcal/kg max. visc 1.5°E at 20°C)

燃料: 轻油 (热值 10,200 kcal/kg 最大黏度 1.5°E at 20°C)

**DETAILS / 技术资料**



HI-LOW with hydraulic system  
两段火型号配备液压系统



HI-LOW with 3 nozzles  
两段火型号配有3颗油咀



Progressive version with servomotor, mechanical cam and pressure regulator  
渐进式型号配有伺服马达、机械凸轮及油压调节器

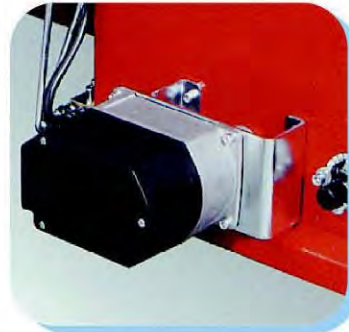

LMV51/52 System  
LMV51/52 系统

**Maior P 800.1 MD**



Modulating version with PID regulation (proportional, integral and derivative) digital control board.  
比例调节型号配有PID调节(比例、积分及微分)数码控制面板



Version with sliding bars  
配有滑动推杆的型号



**HYDRAULIC CIRCUIT / 液压油路**

versions ON-OFF / 单段火型号

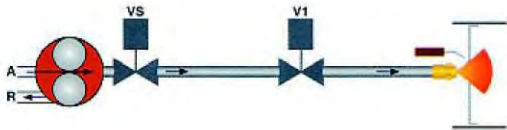

versions with servomotor 2 nozzles  
伺服马达控制型号 (双油咀)

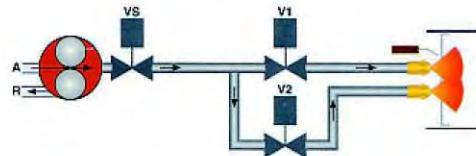

versions with hydraulic system (HS) 2 nozzles  
液压式控制型号 (HS) 双油咀

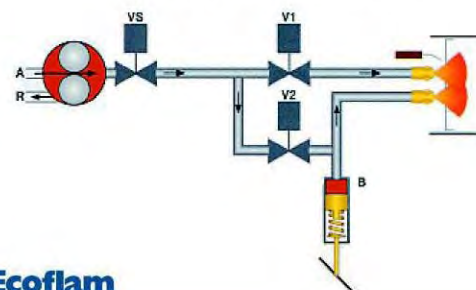

versions with hydraulic system (HS) 3 nozzles  
液压式控制型号 (HS) 三油咀

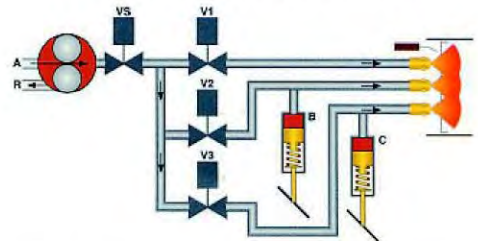

versions with hydraulic pressure regulator (PR)  
液压调节阀型号 (PR)

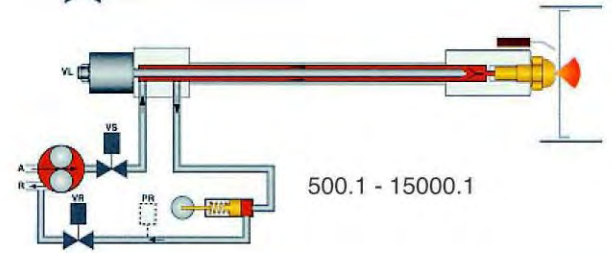
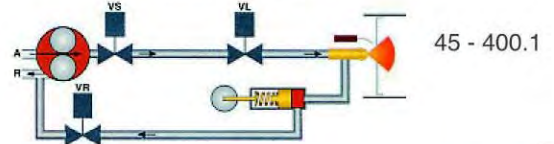

# OVERALL DIMENSIONS / 整体尺寸

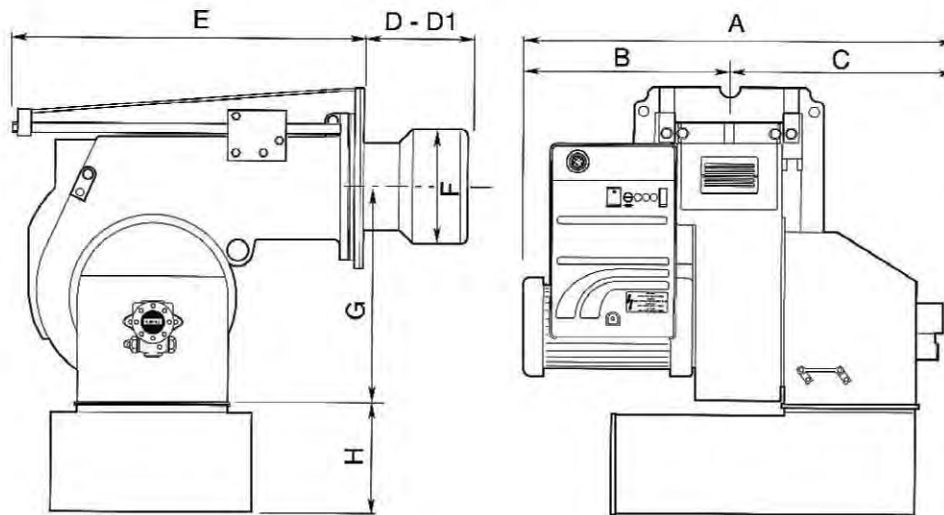
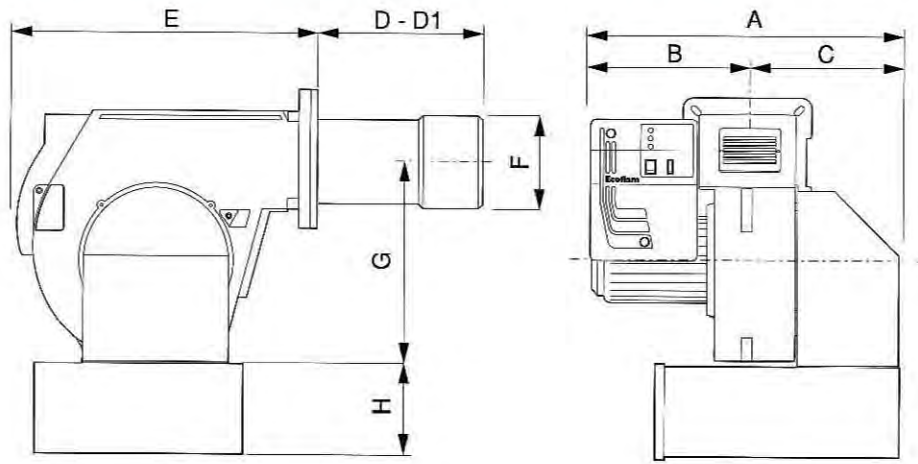

	A	B	C	D	D1	E	F	G	H	I	L	M
MAIOR P 35	370	125	245	205	395	355	160	270	-	190	190	M8
MAIOR P 35 AB	460	215	245	205	395	385	160	270	-	190	190	M8
MAIOR P 45	590	330	260	200	390	555	160	385	225*	190	190	M10
MAIOR P 60	590	330	260	235	395	555	180	385	225*	190	190	M10
MAIOR P 80	590	330	260	235	395	555	180	385	225*	190	190	M10
MAIOR P 120	690	350	340	225	445	555	190	385	225*	190	190	M10
MAIOR P 150.1	775	385	390	285	485	660	250	398	283*	240	240	M14
MAIOR P 200.1	795	405	390	285	485	660	270	398	283	240	240	M14
MAIOR P 300.1	1055	502	553	330	530	810	290	466	280	315	315	M16
MAIOR P 300.1 □	1055	502	553	350	600	890	290	466	280	400	400	M16
MAIOR P 400.1	1100	547	553	345	545	810	320	466	280	315	315	M16
MAIOR P 400.1 □	1100	547	553	350	600	890	320	466	280	400	400	M16
MAIOR P 500.1	1180	535	645	355	555	970	320	565	400	330	330	M16
MAIOR P 500.1 □	1180	535	645	350	600	1000	320	565	400	460	460	M16
MAIOR P 600.1	1190	545	645	355	555	970	320	565	400	330	330	M16
MAIOR P 600.1 □	1190	545	645	350	600	1000	320	565	400	460	460	M16
MAIOR P 700.1 □	1340	585	755	457	-	1247	420	800	480	460	460	M20
MAIOR P 800.1 □	1410	655	755	457	-	1247	420	800	480	460	460	M20
MAIOR P 1000.1 □	1440	685	755	457	-	1247	420	800	480	460	460	M20
MAIOR P 1200.1 □	1550	795	755	457	-	1247	450	800	480	460	460	M20
MAIOR P 1500.1	1670	800	870	457	-	1750	500	1100	530	620	620	M20

D = short head / 短头

D1 = long head / 长头

\* = optional silencer / 消音器(选购)

□ = sliding bars / 滑动推杆

Dimension (mm) / 尺寸 (mm)



#### CHINA SOLE AGENT

##### **Unic Energy (International) Company**

Flat B, 10/F, Effort Industrial Building, 2-8 Kung Yip Street,  
Kwai Chung, New Territories, Hong Kong  
Tel : (852) 2401 3660 / 3665 / 3669  
Fax : (852) 2610 0969  
E-Mail : info@unicenergys.com  
Website : www.unicenergys.com

##### **勁力能源(國際)公司**

香港新界葵涌工業街2-8號力豐工業大廈10字樓B室  
電話 : (852) 2401 3660 / 3665 / 3669  
傳真 : (852) 2610 0969  
電郵 : info@unicenergys.com  
網頁 : www.unicenergys.com

##### **Bon Energy Heating Equipment Company Limited**

B507, Time Creative Park, 179 Dashi Yinbin Road,  
Panyu District, Guangzhou City, Guangdong Province,  
P.R. China.  
Tel : (86) 020 - 3479 3015  
Fax : (86) 020 - 3479 3013  
E-Mail : bon-energy@163.com

##### **廣州市耐源機械設備有限公司**

中國廣州市番禺區大石迎賓路179號時代創意園B507室  
電話 : (86) 020 - 3479 3015  
傳真 : (86) 020 - 3479 3013  
電郵 : bon-energy@163.com



**ECOFLAM S.p.A. - via Roma, 64 - 31023 Resana (TV) - Italy**  
tel. 0423.7160 - 715345 r.a. - fax 0423.715444 - 715538  
<http://www.ecoflam.it> - e-mail: [export@ecoflam.it](mailto:export@ecoflam.it)